

010C2	60	**
	66	
	80	
	93	



Charnière réglable universelle pour portes.

CARACTÉRISTIQUES TECHNIQUES:

- Réglage 3D micrométrique.
- Valables aussi bien pour les ouvertures intérieures que pour les extérieures.
- Modèle de perçage réglable qui facilite l'usinage du profil.
- Disponibilité de cales pour des séries à bossage.

[Voir fiche technique]

Dobradiça regulável universal para portas.

CARACTERÍSTICAS TÉCNICAS:

- Regulação micrométrica em 3 dimensões.
- Válidas tanto para aberturas interiores como exteriores.
- Modelo de perfuração regulável que facilita o mecanizado do perfil.
- Disponibilidade de calços para séries com ressalte.

[Ver ficha técnica]

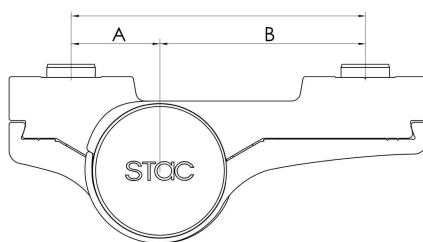
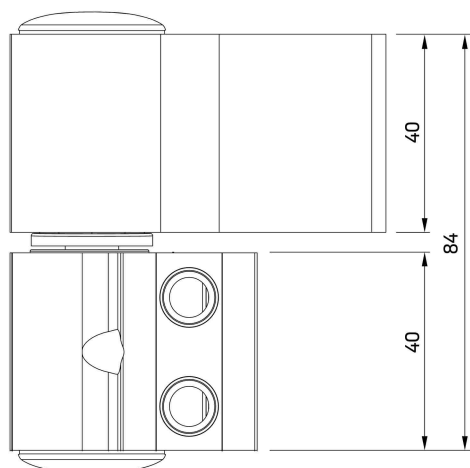

A	B	C
20	40	60
20	46,5	66,5
40	40	80
46,5	46,5	93

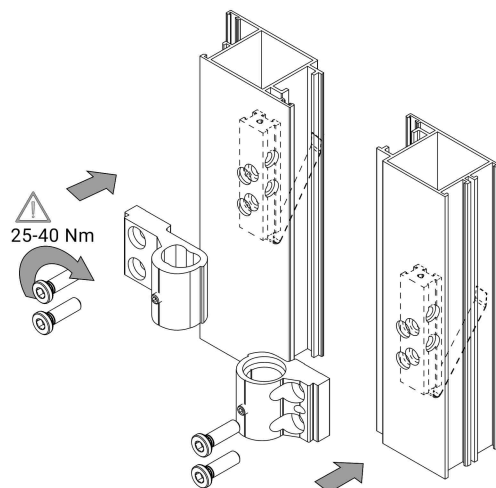
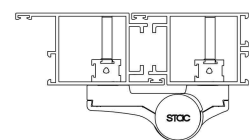
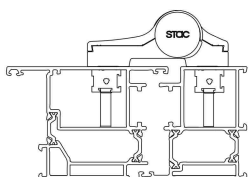
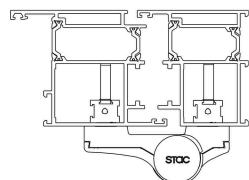
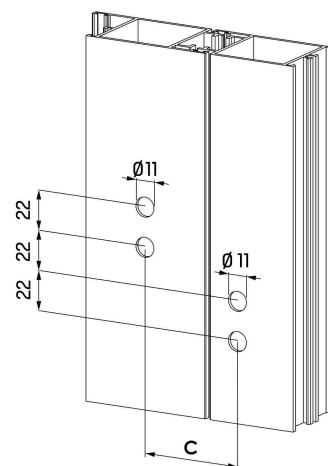

FIXATION TRADITIONNELLE AVEC CONTRES-PLAQUES
FIXAÇÃO TRADICIONAL COM CONTRA CHAPADOS

